

ISM00D

Indego

User Guide

Please read and understand this manual
carefully before using this product.

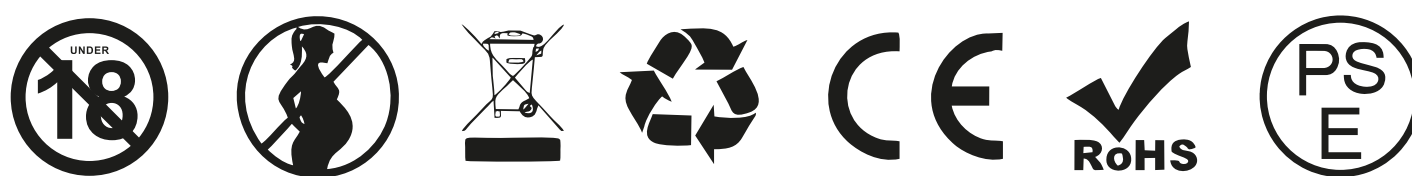

1. SAFETY WARNINGS AND INSTRUCTIONS

1. When you pick up and check the device after delivery, make sure the device is turned off.
2. This device is not suitable for: persons under the age of 18; children, pregnant women, nursing mothers; people with heart disease, high blood pressure, diabetes, nicotine allergies or who take medication to treat depression, asthma and other groups.
3. Keep the device and its components out of the reach of children and pets.
4. Store the device at room temperature. Do not expose the device to excessive heat or humidity.
5. Do not immerse any part or component of the device in water.
6. Do not use this device where flammable substances, liquids, gases or oxygen are present.
7. Do not use this device while it is charging.
8. Do not use a charging device that does not meet the charging requirements.
9. Before cleaning, opening or making direct contact with the internal heating components, you must check that the main body of the device has cooled down.
10. Please use and store the device at an ambient temperature of 5-40. A lower or higher temperature environment may temporarily reduce battery life or cause damage to the device.
11. If you notice any abnormal situation such as smell, or smoke, immediately stop the charging and usage, and contact your service provider.
12. If the battery is leaking from the product, avoid contact with skin and eyes. If you accidentally touch it, immediately wash with clean water and immediately consult a doctor.
13. The precautions contained in the user guide cannot cover all possible situations.

2. OVERVIEW

Buttonless operation. Insert the cartridge of non-combustible tobacco. Detecting the cartridge of non-combustible tobacco. Device for heating the cartridge of non-combustible tobacco with large capacity lithium battery. Smart and modular design. Easy to carry and use.

3. STRUCTURE

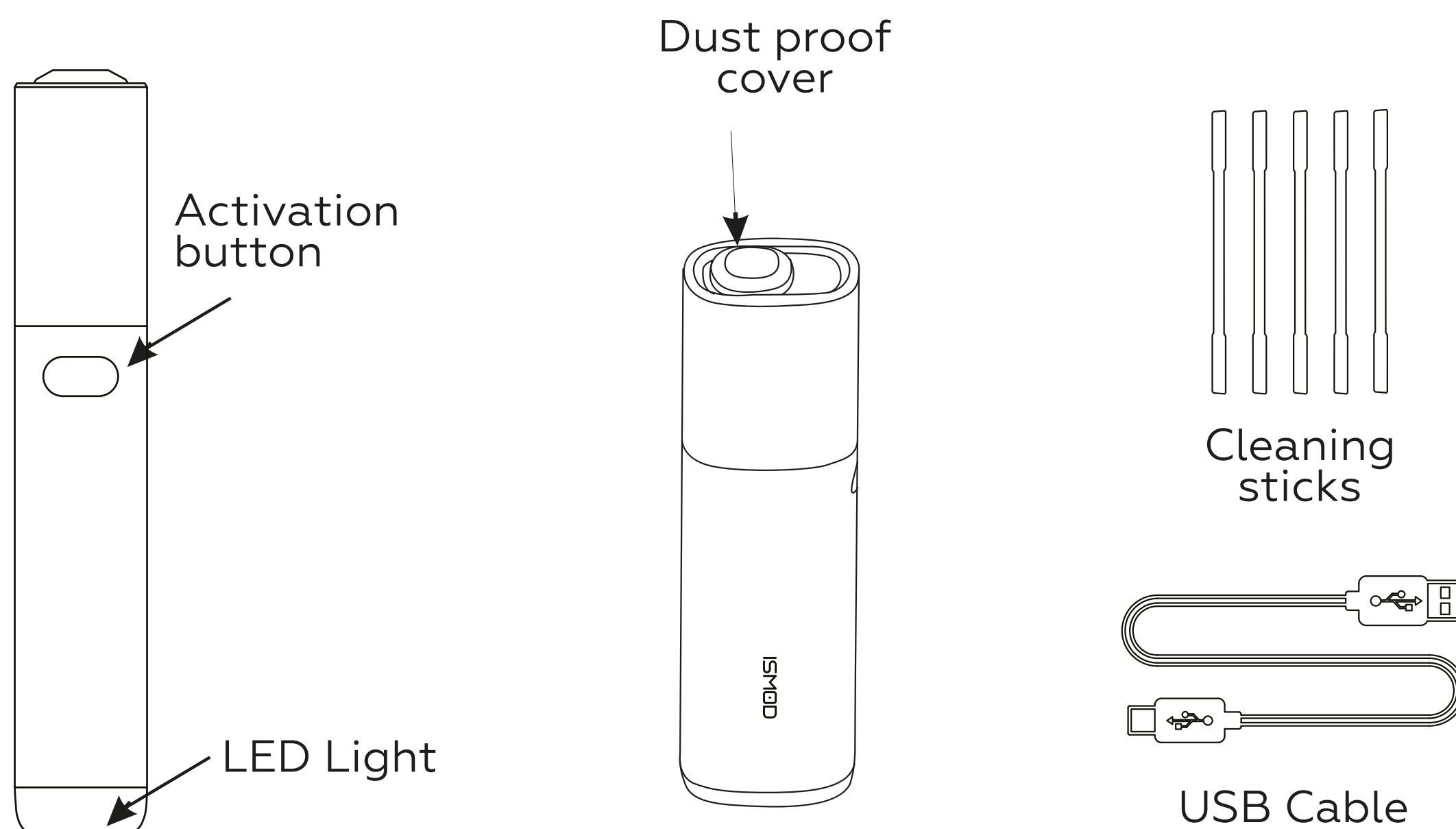

4. SPECIFICATIONS

Model	ISMOD Indego NMate
Battery Capacity	1500mAh.3.7V
Charging Time	Less than 2 hours
Charging Method	USB-Charging port: type C ; Charger setting: 5V/1A
Preheat Duration	15 seconds
Working Duration	15 puffs or 300 seconds
Working Environment Temperature	5~40°C
Product Size	28mm (L) X 18mm (W) X 100mm (H)
Product Weight	57g

Child lock function, press and hold the button for 3 seconds to turn on or off the child lock function.

5. OPERATING INSTRUCTIONS

1. PREPARATION

Rotate the dust proof cover

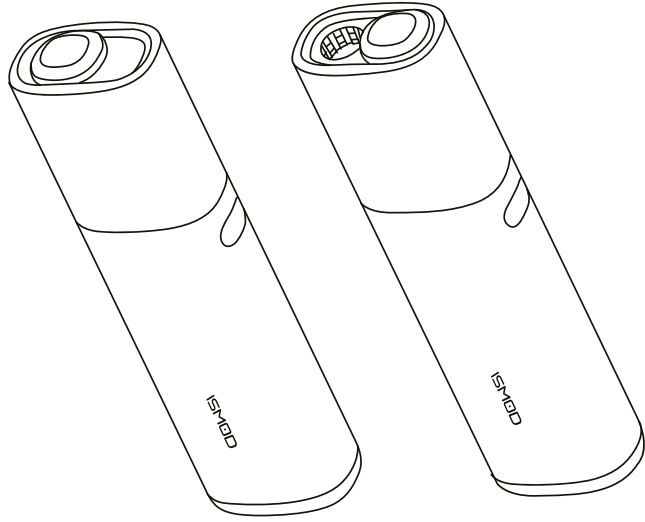

2. INSERTING TOBACCO STICK

Place the cartridge of non-combustible tobacco upright in the chamber, placing the filter outside.

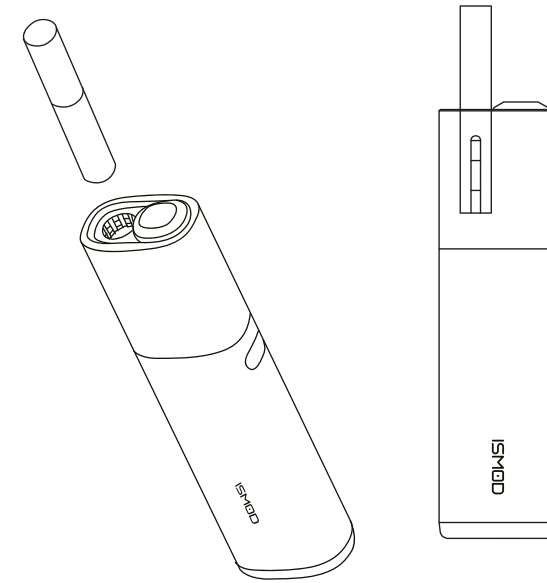

3. HEATING

Insert the cartridge of non-combustible tobacco and the device will start the heating; LED light will indicate the current heating mode. Pre-heating duration is 15 seconds. After the 15 seconds pre-heating process and the LED light shines brightly, you can start to enjoy in consuming. When the consumption time reaches the last 30 seconds or reaches the 13th puff, and the LED indicator light will begin to flash white, indicating that the heating period is almost finished. When the entire consumption time is over or after the 15th puffs, or will reach the total consumption time, indicating that the entire heating process is complete.

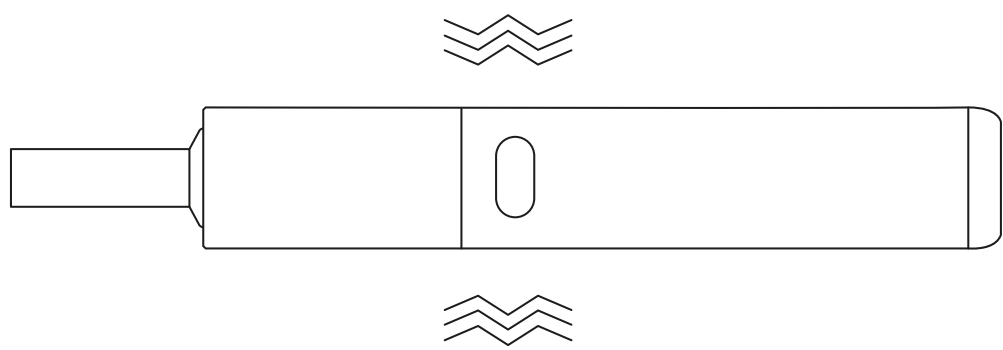

The LED indicator shows the current heating mode

4. REMOVAL OF TOBACCO STICK

(1) Press the push button up and the non-combustible tobacco cartridge will come out of the cartridge holder.

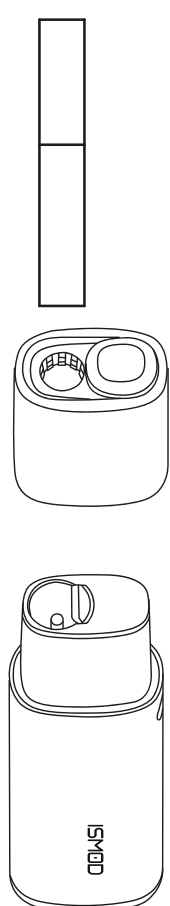

(2) Remove the non-combustible tobacco cartridge and twist the protective cap

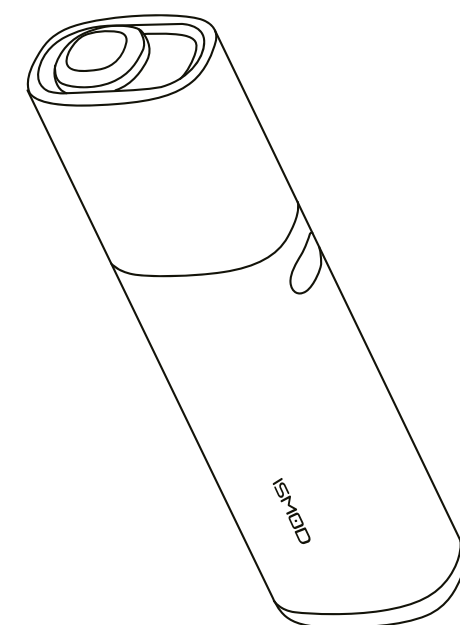

Temperature Adjustment Mode (TA):

To start TA mode, press the button 5 times quickly. The LED Light will flash green, white as an alternative.

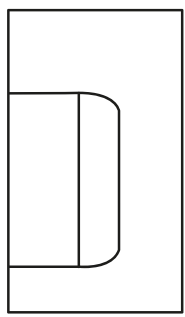

The LED light colour indicates the following:



Green LED indicator: Low temperature

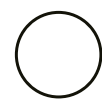

White LED indicator: Middle temperature

Wait for the light indicator to perform a self-test, i.e., to stop shining. Press the button to change the heating mode. One click shows the current heating mode.

Press and hold the power button to confirm the heating mode or wait 10 seconds to exit the (TA) mode.

5. CLEANING THE HEATING CHAMBER

Make sure the device is switched off and cooled down before cleaning.

(1) Detach the top cover from the main body

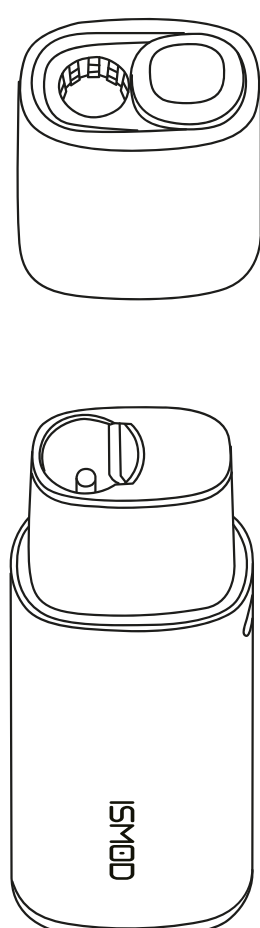

(2) Then use a cleaning stick to clean the heating chamber

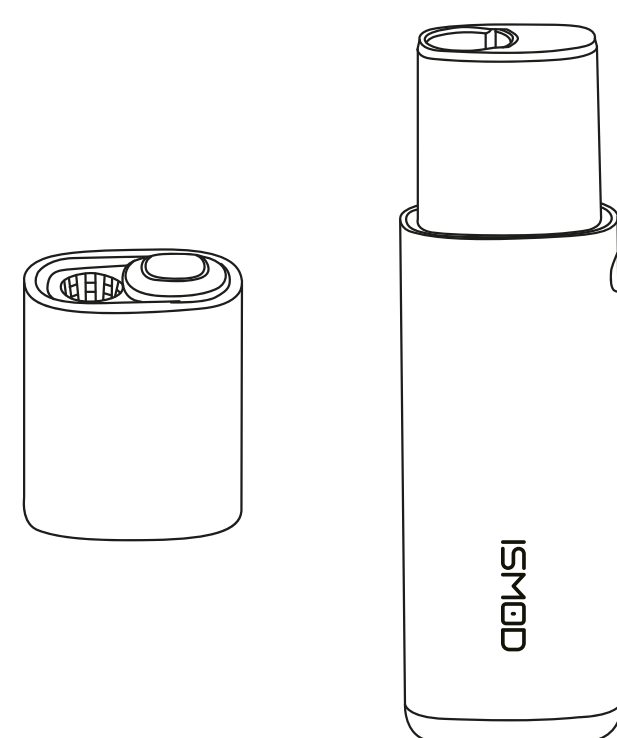

How to use the cleaning sticks?

1. Take out a cleaning stick

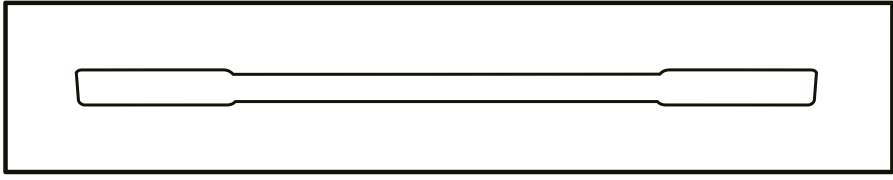

2. Remove the protective film from the packaging and remove the stick.

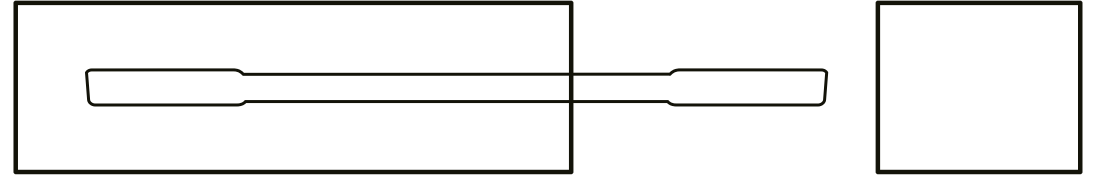

6. CHARGER

Connect the USB cable to the charging adapter. The LED light will flash in different colors to indicate the battery power.

When the device is fully charged, the LED light turns off.

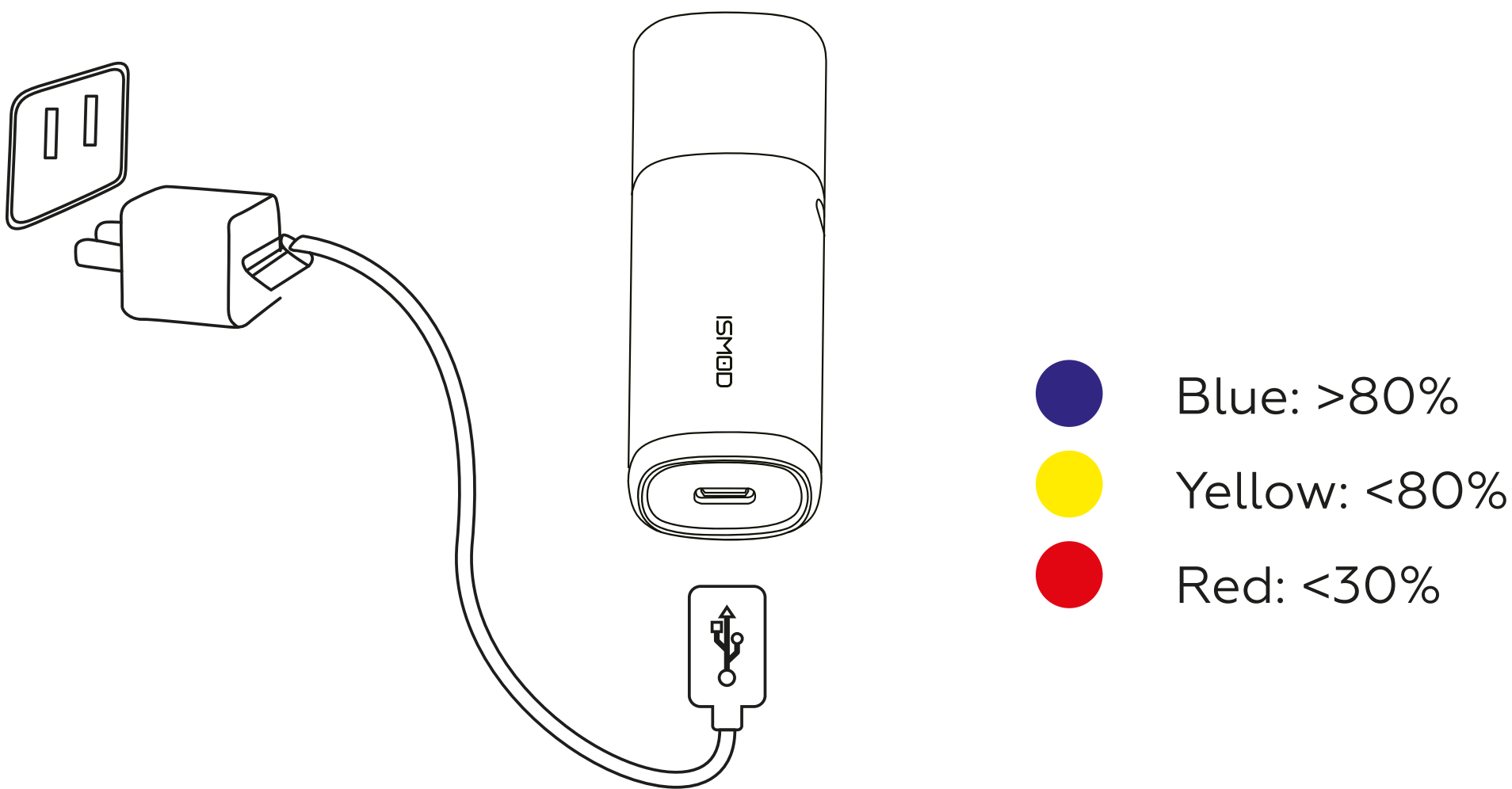

6. OPERATION INSTRUCTIONS



1. INDICATION OF REMAINING POWER

How to check the remaining battery capacity?
Click the Switch button to activate the LED light when the device is turned off.

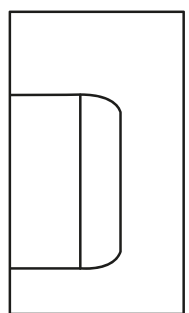
The LED light will indicate the remaining battery capacity.



The LED light color indication are as follows:

-  Blue: >80%
-  Yellow: <80%
-  Red: <30%

2. QUICK SHUTDOWN

The LED light indicates low battery capacity and needs to be charged in time. The indicator light flashes when charging, the LED light will turn off when fully charged.

LED light indication

When the battery is low the red-light flashes 5 seconds. When the heating needle is not working, the red light is always on and it vibrates on every 3 seconds.

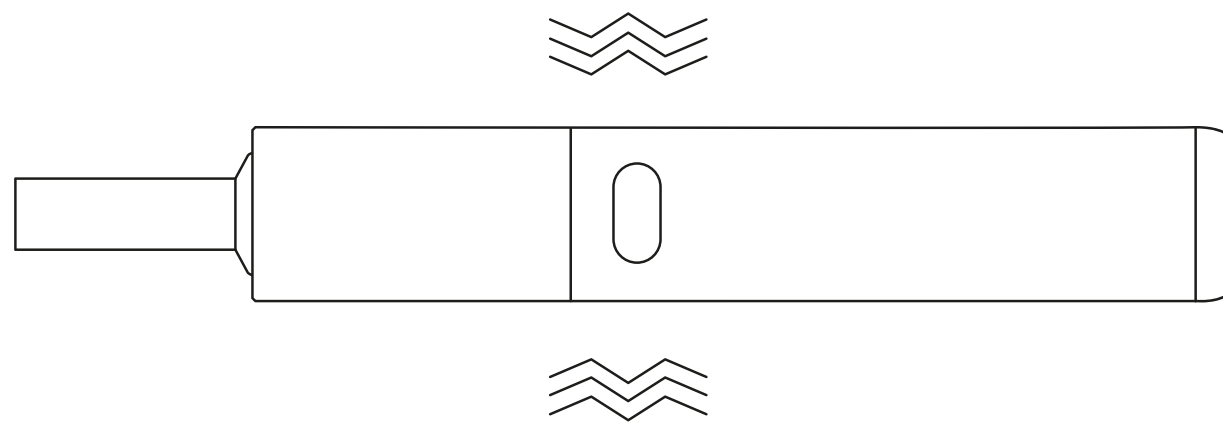

7. TROUBLESHOOTING

Problem	Verification method	Solving method
The device cannot be switched on. A non-combustible tobacco cartridge cannot be inserted into the heating chamber.	Check the remaining power	Charge the device until the charge is complete
	The device has not been used for a long time?	The battery is empty, the device needs to be charged
	The button is damaged?	Send it to your local service center.
	The LED light indicator is damaged?	Send it to your local service center.
Red LED light is flashing 5 seconds	The remaining battery capacity is low	Charge your device immediately.
Red LED light is on constantly and it vibrates for 3 seconds	Check the heating needle	Change the heating needle.

8. DISCLAIMERS

1. ISMOD Indego is battery powered. When the battery level is empty it needs to be recharged. Do not place the ISMOD Indego near a high temperature environment or a heater to avoid battery damage.
2. Read all instructions carefully before using ISMOD Indego. Keep the User Guide for future reference.
3. When using ISMOD Indego follow the manufacturer's instructions to avoid possible injury.
4. The warnings and safety instructions in this user guide cannot cover all possibilities and situations that may arise.
Be careful when using or maintaining your personal electronic product.
5. Use only with an exclusive cartridge of non-combustible tobacco.
6. ISMOD Indego contains lithium batteries, for their disposal follow the requirements of the local government.



LITHIUM BATTERY

1. If the product is stored for a long time at a high temperature, the lithium battery will disintegrate.
2. The battery will discharge when stored for a long time without working.
Charge the device before using it.
3. When you are not using the device for a long time, avoid storing it in a fully charged state or in high temperature/humidity conditions to avoid accelerated battery failure.
4. Avoid placing the battery in fire to prevent explosion hazard.